

Manual DSFOX - X10, XR10



• A user manual for this product is posted on the company website.
 • Please download the technical document and communications manual on the company website
 www.conotec.co.kr

1 Safety precautions

Please read the safety precautions carefully for correct operation of the product.
 ※ The specifications and dimensions specified in this instruction manual may be changed without any notice for performance enhancement.

Warning

1. This product was not made as a safe device. Therefore, this product should be attached with dual safety devices if it is used for the control purposes (e.g. a device vulnerable to accident and property damage, etc.).
2. Do not wire, inspect or service this product while the power is being supplied.
3. You must attach this product to a panel. Otherwise, it may cause an electric shock.
4. When connecting the power, you must check the terminal number.
5. Do not ever disassemble, process, modify or repair this product.

Caution

1. Please make yourself familiar with all the operation instructions, safety precautions and warnings before using this product. Comply with related specifications and capacity requirements
2. Do not wire or install this product to any unit with high inductive load (e.g. motor, solenoid, etc.).
3. Use a shielded cable with a proper length when extending a sensor.
4. Do not use any part that generates an arc when used in the same power or directly switched in close proximity.
5. Keep the power cable away from a high-voltage cable and do not install this product in any place that is full of water, oil and dust.
6. Do not install this product in any place that is exposed to direct sunlight or rain.
7. Do not install this product in any place that is subject to strong magnetic power, noise, vibration or shock.
8. Keep this product away from any place that generates strong alkaline or acid substances. Use a separate pipe.
9. Do not sprinkle water onto this product for cleaning when installing it in the kitchen.
10. Do not install this product in any place where the temperature/humidity ratings are exceeded
11. The sensor cable should not be cut or cracked.
12. Keep the sensor cable away from a signal cable, a power cable or a load cable. Use a separate pipe.
13. Keep in mind that the follow-up service will not be available if this product has been arbitrarily disassembled and modified
14. ⚠ symbol on the terminal wiring diagram indicates a safety statement that alerts a warning or caution.
15. Do not use this product near any device generating strong high-frequency noise (e.g. high-frequency welding machine, high-frequency sewing machine, high-frequency radio, large-capacity SCR controller, etc.).
16. Using this product in any method other than those specified by the manufacturer may lead an injury or a property damage
17. This product is not a toy. Keep it away from children

18. This product should be installed only by an expert or a qualified person.
19. The company will not be liable for any damage caused by the violation of the above warnings and cautions or by a consumer's fault

Danger

- Caution: Risk of electric shock
- Electric shock - Do not touch the AC terminal while the current current is flowing. It may cause an electric shock.
 - You must disconnect the input power when servicing it.

2 Model types

Model	Sensor	Control Type	Temperature Range	Power	Function
DSFOX-X10	NTC 10K	Relay contact (1EA)	Celsi - 55.0 °C Us: + 99.9 °C	100~240 VAC 50/60Hz	Temperature control
DSFOX-XR10			Fahren - 60 °F het: + 200 °F		Temperature control 485 communications

3 Components

■ Product appearance and components

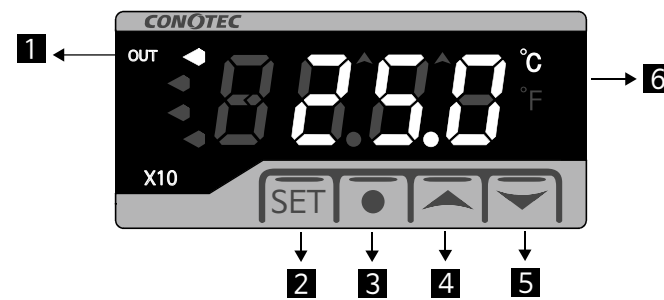

- 1 OUT output display 2 SET switch 3 Back switch
 4 Up switch 5 Down switch 6 Temperature unit

4 Terminal wiring diagram

[DSFOX - X10]

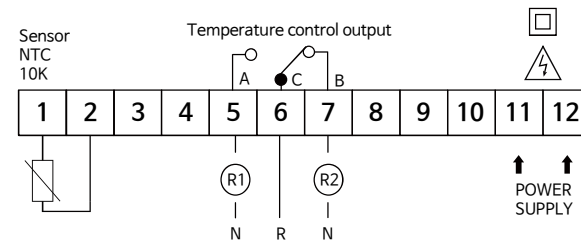

[DSFOX - XR10]

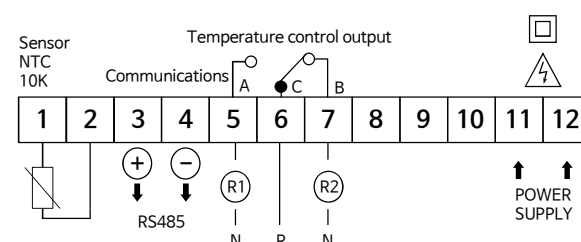

※ Output: 250VAC 2A: A power relay or a magnet must be used.
 ※ Be careful that any load over the contact capacity may cause contact fusion, contact defect, relay damage or others

5 Setting process

Setting method

Name	Image	Description
SET key	SET	Entry into or return to the settings page Selection and saving of data values
Back switch		Go to the previous menu when setting up a program
Up/down key	▲ / ▼	Increment/decrement of the selected menu data

- Change of the temperature output's set temperature (temperature setting)
- 1) If you press the SET key once, the setting will blink and be displayed
 - 2) Increase or decrease the setting with the ▲ or ▼ key.
- Installer mode settings (Program settings)
- 1) Press the SET key for at least 5 seconds to enter into the installer mode.
 - 2) Configure the program based on the temperature program configuration diagram.
 - 3) Press ● key for Enter the previous setting menu (* Program setting mode only)
- System running / stopping (only XR10)
- 1) In the running mode : System shut down by pushing ● + ▲
 - 2) In the stop mode : System runs by pushing ● + ▲

Temperature setting

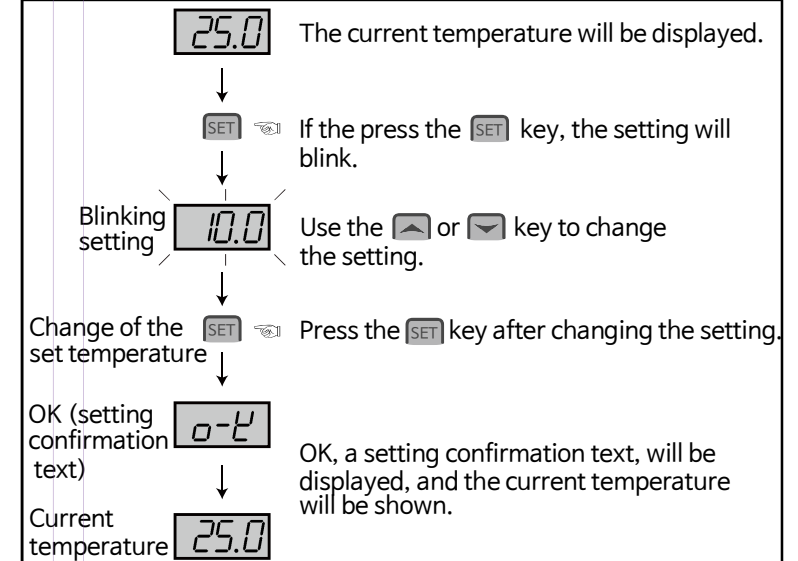

Program setting

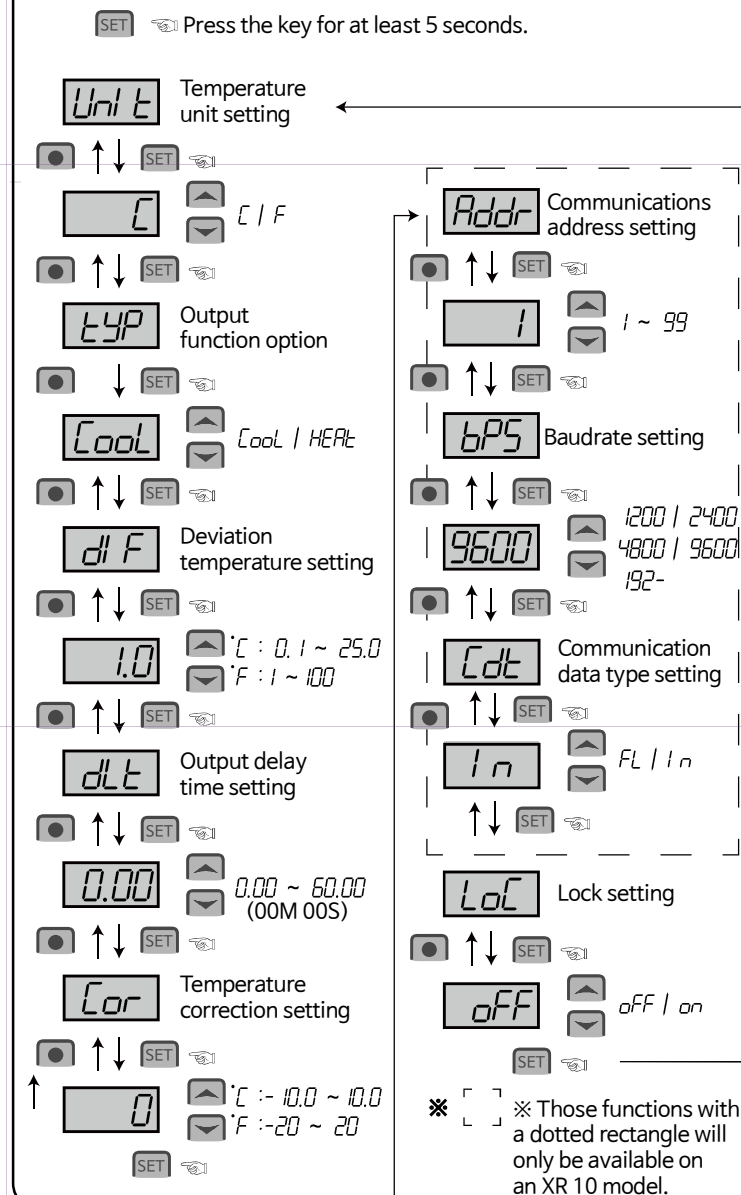

※ [] ※ Those functions within a dotted rectangle will only be available on an XR 10 model.

6 Function details

Unit : Change of the temperature unit
 - C (temperature displayed in Celsius)
 - F (temperature displayed in Fahrenheit)

※ Note: If you change the **Unit** while the product is running, all the settings except for the unit will be initialized to factory settings. Please reset all the settings.

Typ : Output function option

- Cooling (Cool) or heating (Heat)

dIF : Deviation temperature setting

- For on/off control, there should be a certain interval between on and off.
 - A relay or other output contacts may be quickly damaged or experience hunting (electricity generation, chattering, etc.) due to an external noise if the on/off function is used too frequently.
 - Different temperature is set to prevent such phenomenon and protect relevant contacts.

- Example 1) Set temperature : 20.0°C, **Typ** : Cool, **dIF** : 5.0
 - Example 2) Set temperature : 20.0°C, **Typ** : Heat, **dIF** : 5.0

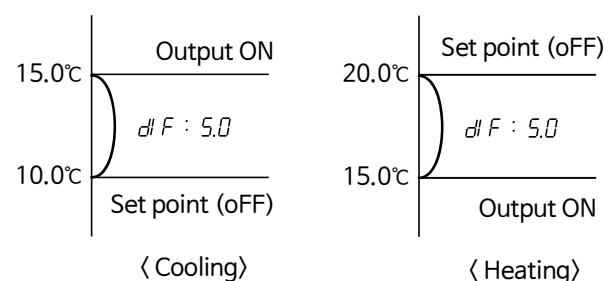

dLT : Output delay time setting

- Used if the on/off function of a control target is used too frequently (freezer, compressor, etc.)
 - Protects running machine from momentary outage or power re-connection
 e.g.) When is the output on for the following conditions:
 set temperature (10.0°C); **dLT** (00.30); **dIF** (5.0°C)?

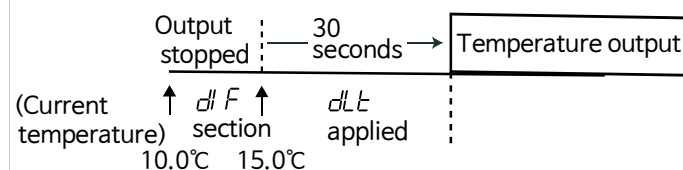

Cor : Correction of the current temperature

- Used to correct the current temperature based on the reference temperature (e.g. mercury thermometer, existing thermometer, thermostat, etc.) when there is an input error by an external sensor even though the product itself does not have any problem

e.g.) Actual temperature: 10.0°C
 Display window : 12.0°C → **Cor** Modification of 0.0 to -2.0
 → Displayed as 10.0 (current temperature modified)

Addr : Communications address setting
 - An address from 1 to 99 should be specified for RS485 communications

bPS : Baudrate setting
 - 1200BPS / 2400BPS / 4800BPS / 9600BPS / 19200BPS

LoL : Locking of the setting
 - Safety function intended to prevent anyone other than the main user from changing the settings
 - If set at on: All the settings except for the set temperature will be locked.
 - If set at off: All the settings will be unlocked.

7 Setting range and factory settings

Display	Function	Applicable range in Celsius	Applicable range in Fahrenheit	Factory setting	Remarks
	Temperature setting	-55.0 ~ 99.9	-60 ~ 200	10.0	
Unit	Temperature unit	C / F		C	C : Celsius F : Fahrenheit
Typ	Output function option	Cool / Heat		Cool	
dIF	Deviation temperature setting	0.1 ~ 25.0	1 ~ 100	1.0	
dLT	Output delay time setting	0.00 ~ 60.00		0.00	minutes, seconds
Cor	Temperature correction setting	-10.0 ~ 10.0	-20 ~ 20	0.0	Correction of the difference between the displayed temperature & actual temperature
Addr	Communications address	1 ~ 99		1	
bPS	Baudrate setting	1200 / 2400 / 4800 / 9600 / 19200		9600	1200 : 1200bps 2400 : 2400bps 4800 : 4800bps 9600 : 9600bps 19200 : 19200bps
dLT	Communication data type setting	FL / Ln		Ln	
LoL	Lock option	on / off		off	

8 Communications specifications

Applicable standard	EIA RS485
Maximum units accessed	32 units (however, 1 ~ 99 available for address setting)
Communications method	2-line half-duplex; Asynchronous
Data speed	1200/2400/4800/9600/19200bps(5 options)
Communications range	Within 1.2 km
Communications protocol	Modbus
Start bit, Stop bit	1 bit (fixed)
Parity bit, Data bit	Parity bit: None, Data bit: 8 bit (fixed)

※ Please see the user manual on our website for more details about the communications specifications..

Product dimensions and panel processing dimensions

9

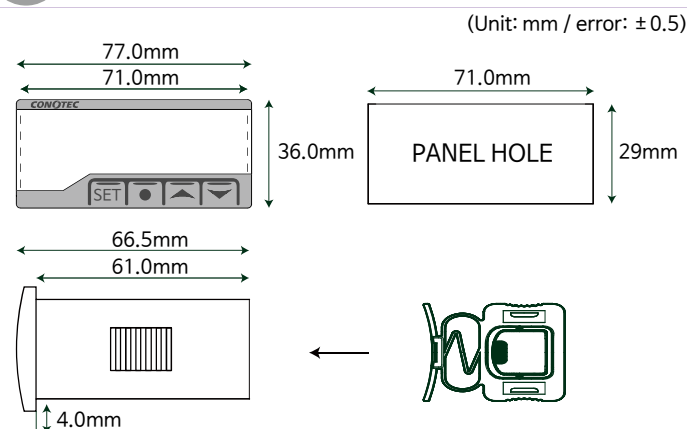

10 Easy error diagnosis instructions

※ If an error is displayed while the product is running

- **Eri** : It is a case where the product was subject to a strong external noise and internal data memories have been damaged
 In this case, contact us for product service
- Although this controller was designed to withstand a certain level of external noise, it is not supposed to withstand all levels of noise
- If the product is subject to a noise greater than 2KV, it could be internally damaged.
- If 'o-E' (open error) or 'S-E' (short error) is displayed, there is something wrong with a sensor. Please check the sensor
- If 'o-L' (OK) is displayed, settings have been saved.
- A text such as 'LoL' (lock) indicates that the product is in the lock mode
- If 'E 10' (product name) is displayed, it refers to a model name.
- If 'Er 10' (product name) is displayed, it refers to a model name.

MEMO

※ The above specifications may be changed without any notice for performance enhancement. Please make yourself fully familiar with and follow the above precautions.

■ Address: (Street address) 56, Ballyongsandan 1-ro, Jangan-eup, Gijang-gun, Busan, ROK
 (Land-lot address) 901-1, Ballyong-ri, Jangan-eup, Gijang-gun, Busan, ROK (46034)

• Product service : 070-7815-8266
 • Customer service: 051-819-0425 ~ 0427
 • FAX : 051-819-4562 • Website : www.conotec.co.kr
 • Email : conotec@conotec.co.kr
 • SNS : Facebook, Instagram, Twitter, YouTube Search for 'Conotec'

◆ Installation precautions

- This device should be connected to a protective earth terminal and a power supply in order to prevent an electric shock.
- Do not block the air outlet.

◆ Operation precautions

- ※ An operating environment of this device is as follows.
- Ambient temperature: 0 ~ 60°C
 - Ambient humidity: 80% RH or less
 - Indoor uses only
 - Pollution class: 2
 - Altitude under 2000m
 - Installation category: II
 - This device should be laid out in a way that its power cord is easy to handle
 - Using this product in any method other than those specified by the manufacturer may damage its protection function

■ Major products and development

- Temperature/humidity controller
- Counter and timer controller
- Current and voltage panel meter
- Temperature/humidity indicator
- Oven controller
- CO2 controller
- PID controller
- Unit cooler controller
- Heat pump controller
- Chiller controller
- Thermo-hygrostat controller
- Short message alarm
- Temperature/humidity transmitter
- Smartphone app and monitoring system